

HOCHGEBIRGSHÜTTE »MOSER-HÜTTE«



»MOSER CHALET« ALPINE HUT

REFUGE DE HAUTE MONTAGNE »CHALET MOSER«

BERGHUT »MOSER-HÜTTE«

Art. Nr. 130329

D

Machen Sie sich bitte vor Beginn des Bastelns mit dem Bausatzinhalt und der Anleitung vertraut und prüfen Sie die Vollständigkeit. Im Reklamationsfall gilt die gesetzliche Gewährleistungspflicht. Sollte ein Teil fehlen, übersenden Sie bitte den Teilwunsch und den Kaufbeleg an: Gebr. FALLER GmbH, Kundendienst, Kreuzstraße 9, D-78148 Gütenbach, kundendienst@faller.de. Sollten Sie einmal weitere Ersatzteile benötigen, senden wir Ihnen den benötigten Spritzling, bei Verfügbarkeit, gerne kostenpflichtig zu. Bitte beachten Sie, dass produktionsbedingt Einzelteile übrig bleiben können.

GB

Before building your model, please familiarize yourself with the contents of the kit and the instructions for use, also checking whether the set of parts is complete. In case of any complaint, the legal guarantee obligation shall apply. Should a part be missing, please send the designation of the part required and the receipt documenting your purchase to: Gebr. FALLER GmbH, Kundendienst, Kreuzstraße 9, D-78148 Gütenbach, kundendienst@faller.de. Should you require further spare parts one day, we shall be pleased to send you, with costs, the required sprue, if it is available. Please note that, on grounds of the production process, some single injection molded parts may be superfluous.

F

Avant de commencer votre modèle, veuillez vous familiariser avec le contenu du kit et la notice d'emploi, et contrôlez que le lot de pièces est complet. En cas de réclamation, il s'appliquera l'obligation de garantie légale. Au cas où une pièce manquerait, veuillez envoyer la désignation de la pièce souhaitée et le bon d'achat à: Gebr. FALLER GmbH, Kundendienst, Kreuzstraße 9, D-78148 Gütenbach, kundendienst@faller.de. Au cas où vous auriez besoin un jour d'autres pièces détachées, nous vous enverrons volontiers la grappe requise, si elle est disponible, contre paiement. Veuillez noter que, pour des raisons de production, il se peut que des pièces détachées soient superflues.

NL

Maak uzelf vóór het bouwen vertrouwd met de inhoud van het bouwpakket en met de handleiding en controleer de volledigheid. In geval van reclamatie geldt de wettelijke garantieverplichting. Mocht er een onderdeel ontbreken, stuur het verzoek om de gewenste onderdeel en het aankoopbewijs dan naar: Gebr. FALLER GmbH, klantenservice, Kreuzstraße 9, D-78148 Gütenbach, kundendienst@faller.de. Als u ooit meer reserveonderdelen nodig hebt, sturen wij het benodigde gietstuk, indien beschikbaar, graag tegen betaling naar u op. Let op: om productieredenen kunnen losse onderdelen overblijven.

Für den Zusammenbau des Modells empfehlen wir folgende FALLER-Artikel (sind nicht im Bausatz enthalten):

For the assembly of the kit we recommend following FALLER products (not included in the kit):

Pour l'assemblage du modèle, nous vous recommandons les articles FALLER suivants (non inclus dans le kit):

Om dit model te bouwen adviseren wij de volgende FALLER producten (maken geen deel uit van deze bouwset):



Art. Nr. 170492
FALLER-EXPERT

Flüssigkleber in Plastikflasche mit Spezialkanüle für feinste Klebstoffdosierung.

Liquid cement in plastic bottle with canule for very fine dosage.

Cette liquide en bouteille plastique avec bec verseur pour un dosage précis.

Vloeibare lijm in plastic-flescom met doseerbuisje om nauwkeurig te lijmen.



Art. Nr. 170688
SPEZIAL SEITENSCHNEIDER

zum gerätfreien Abtrennen von feinsten Spritzteilen.
Nur für Polystyrol geeignet.

Special side cutter for cutting off ultra-fine moulded parts without burrs.
Only suitable for polystyrene.

Pince coupants spéciale pour couper sans bavure les pièces miniatures moulées par injection. Convient uniquement au polystyrène.

Speciale zijknijplang voor het braamloos afknippen van de fijnste gietstukdelen. Alleen geschikt voor polystyrol.



Inhalt	Spritzlinge	1 a	1 x	3 A	1 x	5 AB	1 x	9 B	1 x
Contents	Sprues	2 a	1 x	3 B	1 x	5 C	1 x	14 A	1 x
Contenu	Moulages	2 A	1 x	4 A	1 x	5 D	1 x		
Inhoud	Gietstukken	2 B	1 x	4 B	1 x	9 A	1 x		

Sa. Nr. 164 755 1

2

Fensterfolie

Die beiliegende Fensterfolie entsprechend der benötigten Größe ausschneiden und vorsichtig mit wenig Klebstoff auf die Rückseite der Fensterrahmen aufkleben.

Window foil

Cut the attached window foil according the illustrations and glue it carefully with a little glue to the rear side of the window frames.

Feuillet transparent pour fenêtres

Découper le feuillet transparent pour fenêtres inclus d'après l'illustration. Coller proprement avec un peu de colle sur la face arrière du cadre des fenêtres.

Vensterfolie

De meegeleverde vensterfolie conform de afbeeldingen uitknippen of uitsnijden en voorzichtig met een beetje lijm op de achterzijde van het raam plakken.

ACHTUNG: Farbrückstände vom patinieren unbedingt von allen Klebeflächen entfernen!

ATTENTION: Before glueing please make sure to remove all patina colour remains from all surfaces to be glued!

ATTENTION: Les résidus de peinture générés par la patine sont à enlever de toutes les surfaces à encoller!

BELANGRIJK: Verfresten van het patinieren van alle lijmvlakken verwijderen!

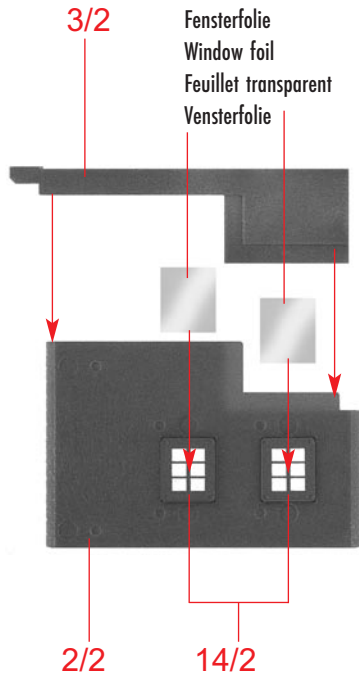

A

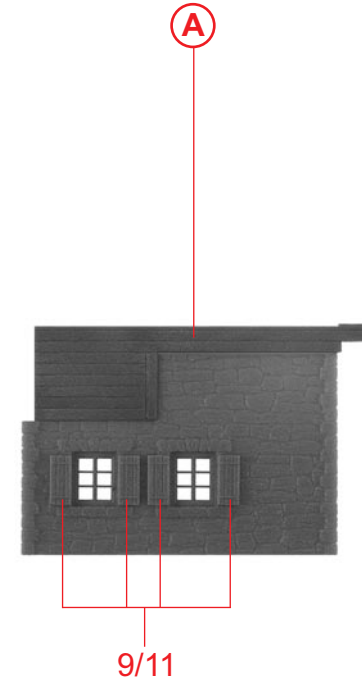

B

Fensterfolie
Window foil
Feuillet transparent
Vensterfolie

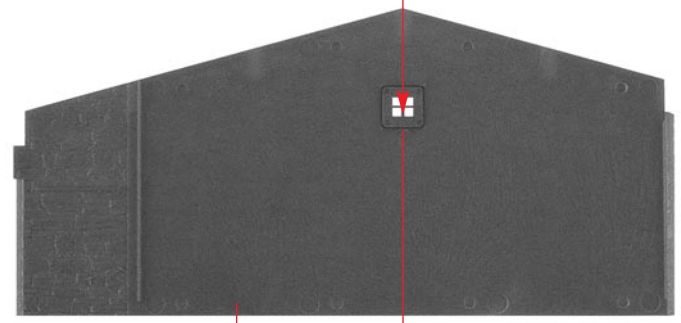

C

2/3 14/3

3/16

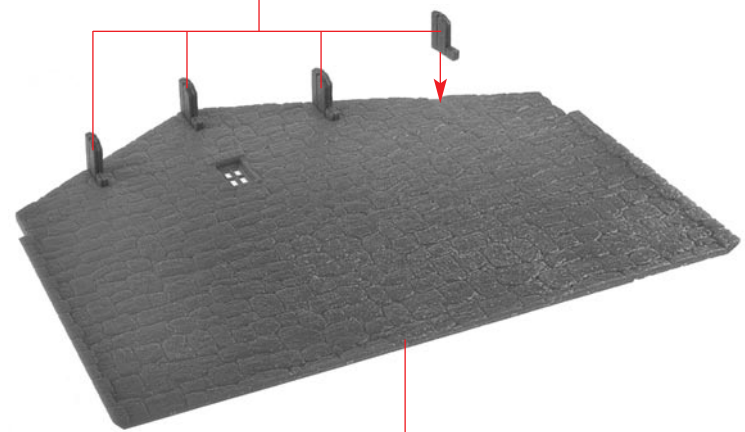

D

C

Fensterfolie
Window foil
Feuillet transparent
Vensterfolie

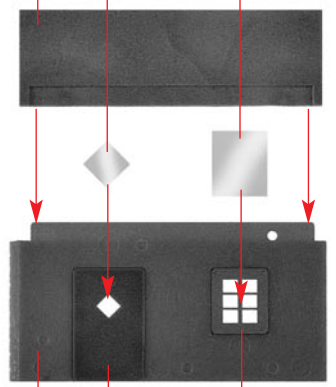

E

2/6 3/22 14/2

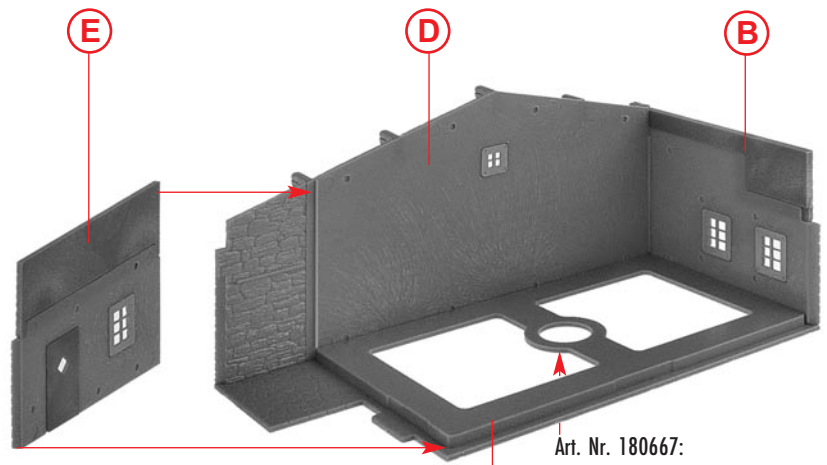

F

5/4

Art. Nr. 180667:
Beleuchtung, liegt nicht bei
Illumination, not included
Eclairage, non jointe
Verlichting, niet bijgevoegd

4

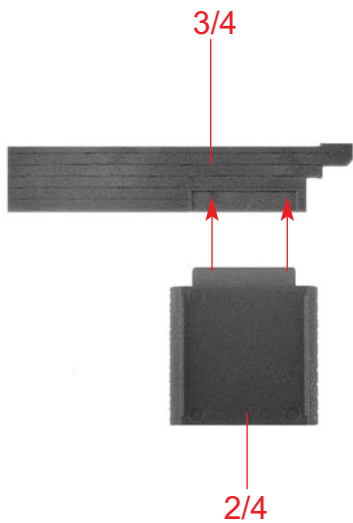

G

H

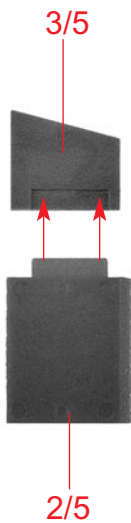

I

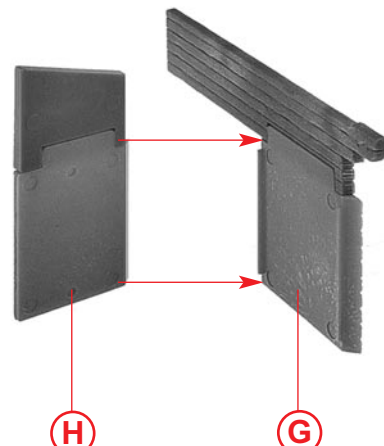

H

G

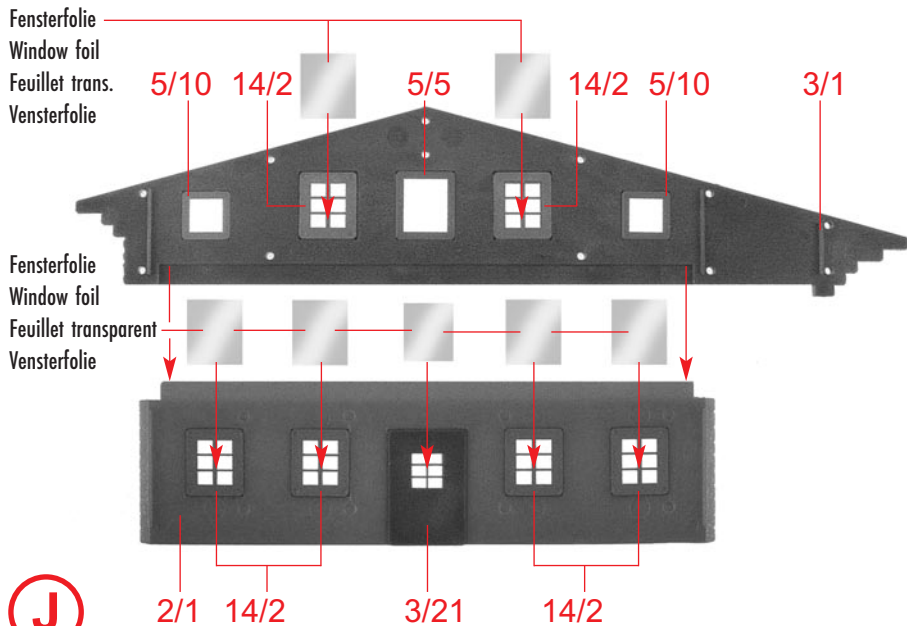

J

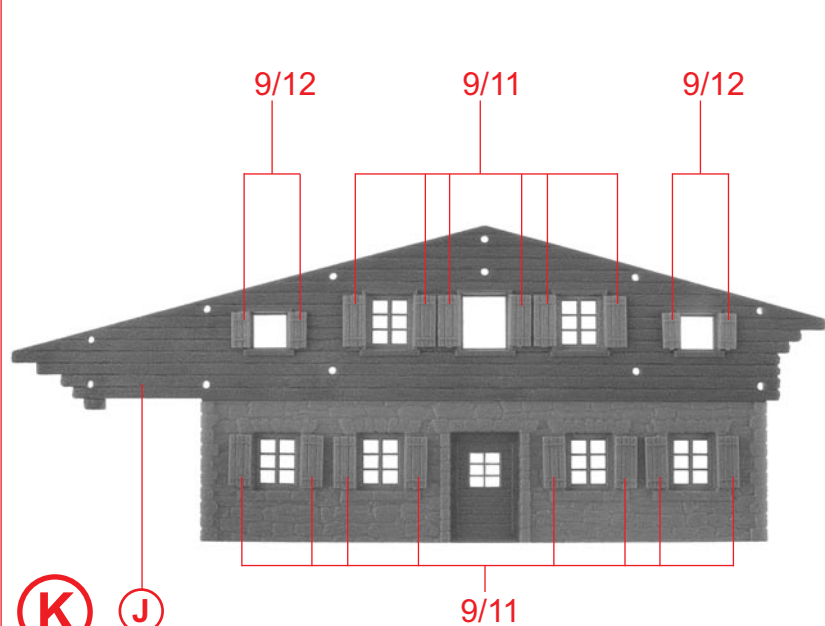

K

J

Bemalungshinweis
Painting instruction
Instruction de coloration
Schilderadviezen

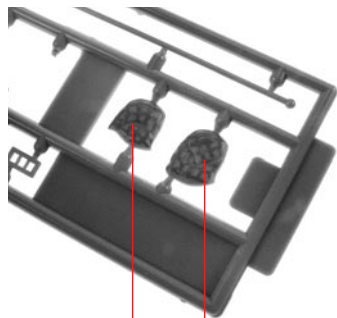

L

5/8 5/9

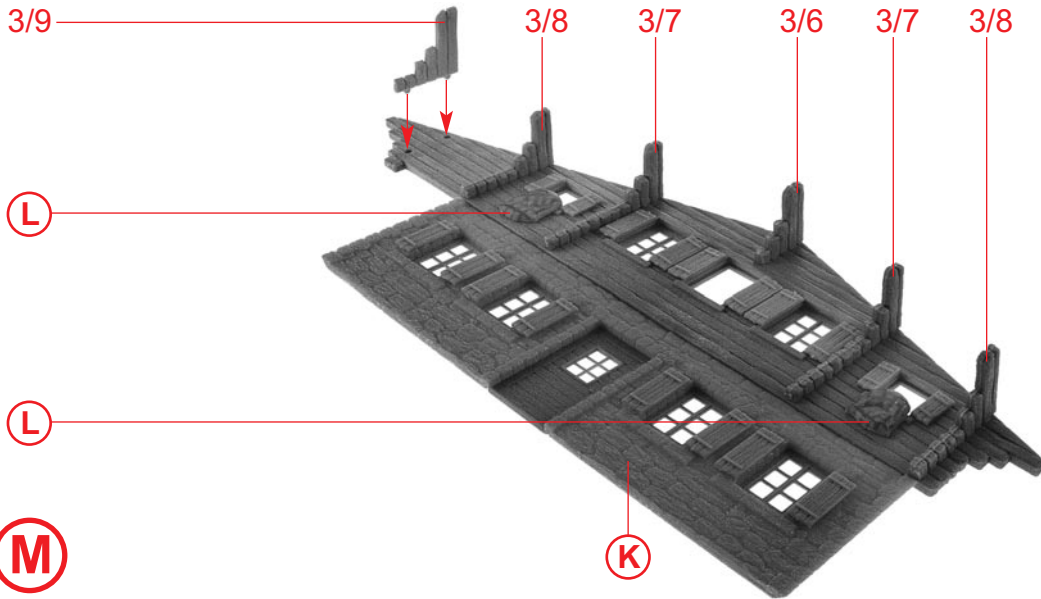

Bemalungshinweis
Painting instruction
Instruction de coloration
Schilderadviezen

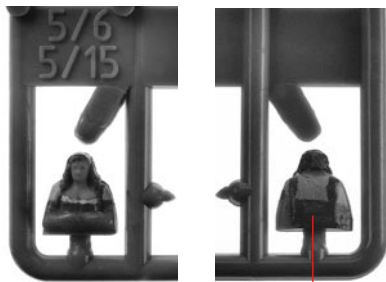

N

5/15

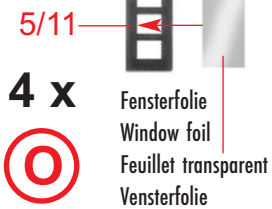

4 x

O



2 x

P

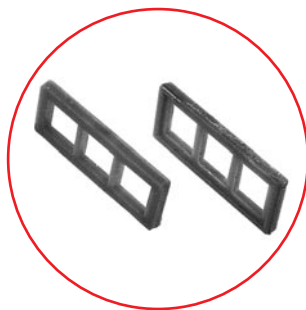

Q

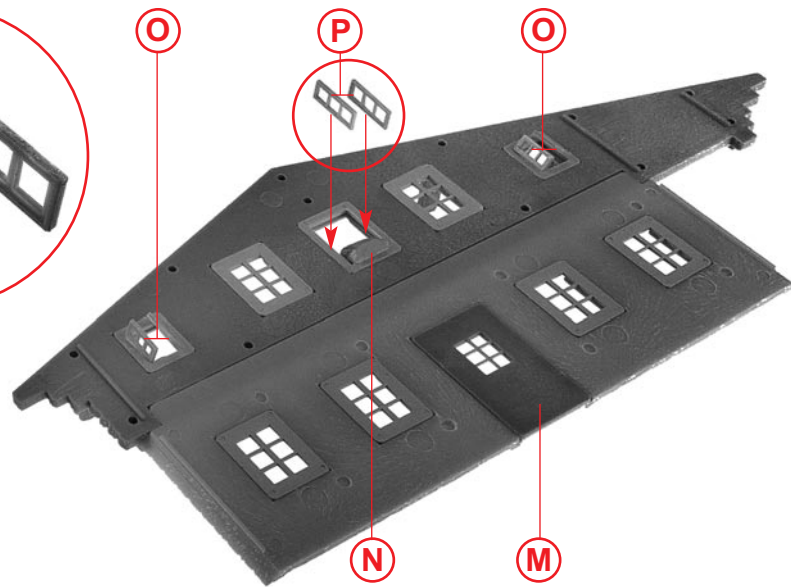

6

F
Papiermaske
Papermask
Masque
Masker

I

R

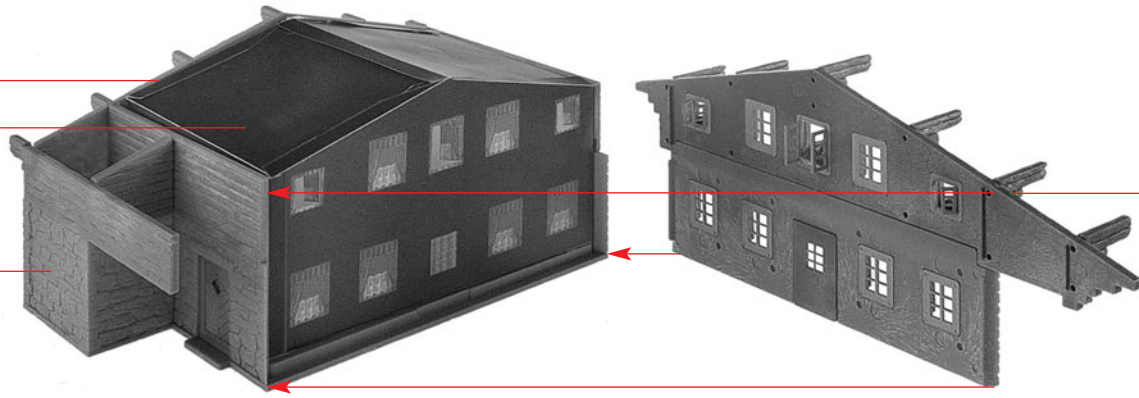

Q

3/24

3/15

S

R

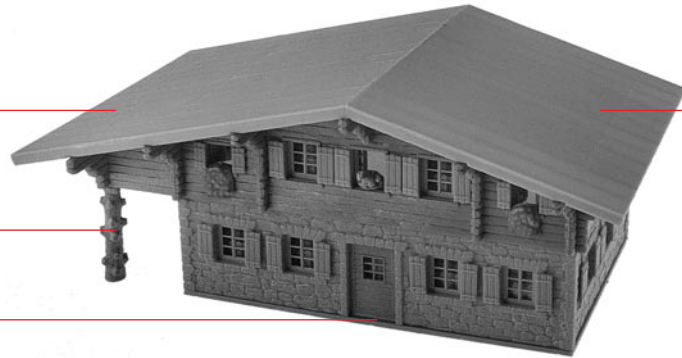

3/23

5/2

3/13

T

3/12

3/11

5/1

3/10

S

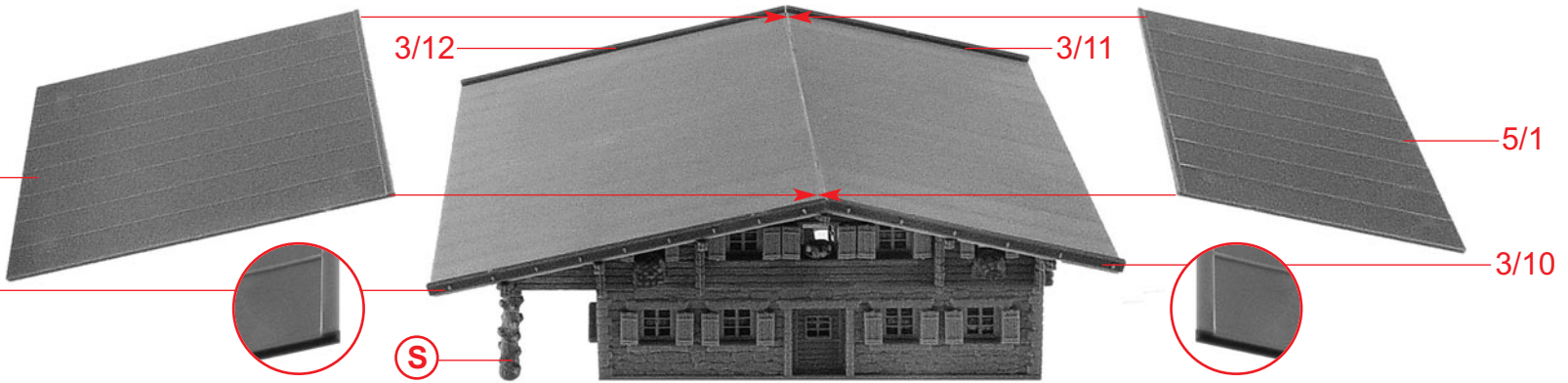

2/11



U

2/9

2/11



V

2/10

Deco 2



W

3/14

Deco 5

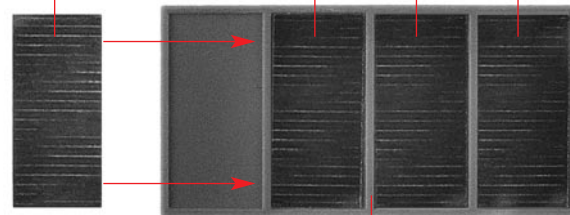

X 2 x

5/3

Inhalt	Tüte	Contents	bag
Contenu	sachet	Inhoud	zakje

U

V

X

Y

T

3/20

W

3/20

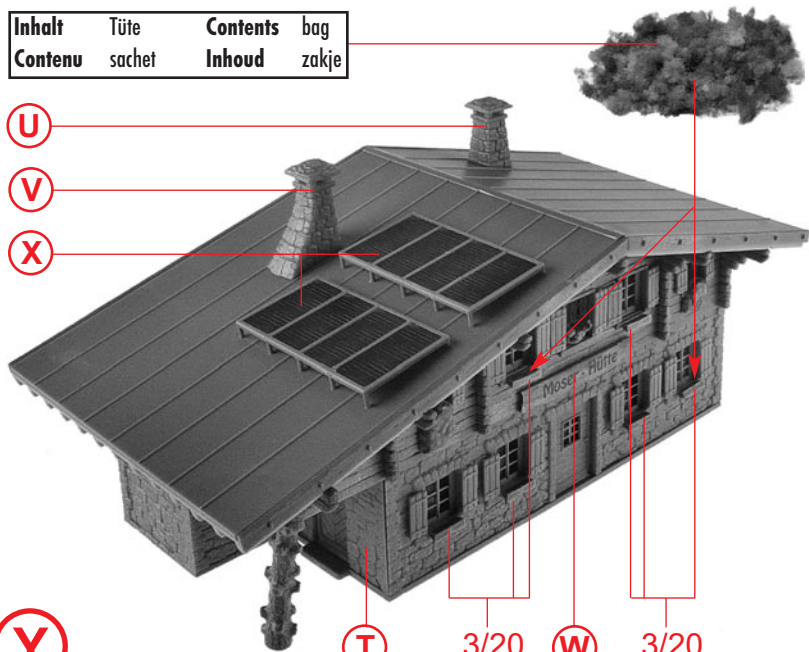

Inhalt	Tüte	Contents	bag
Contenu	sachet	Inhoud	zakje

Z

Y

3/20

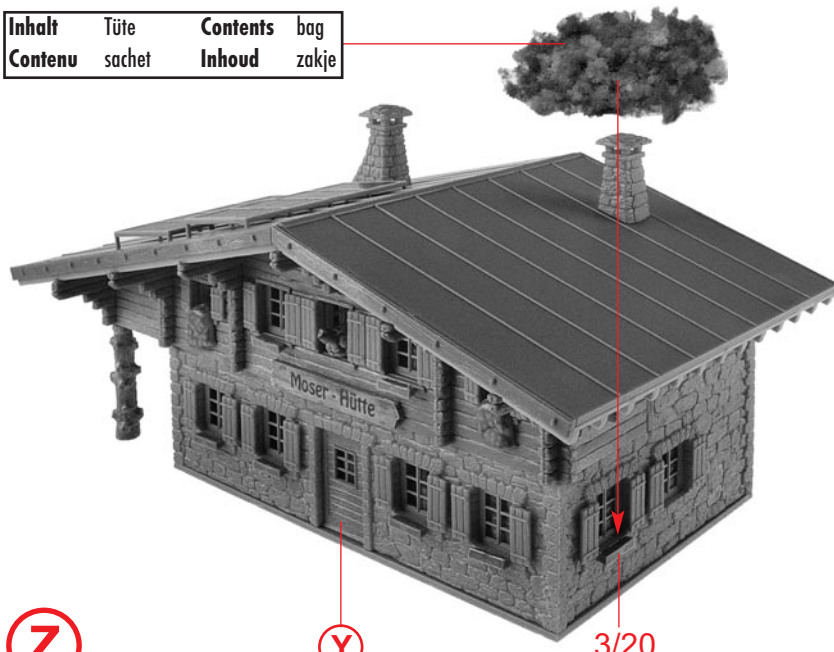

8

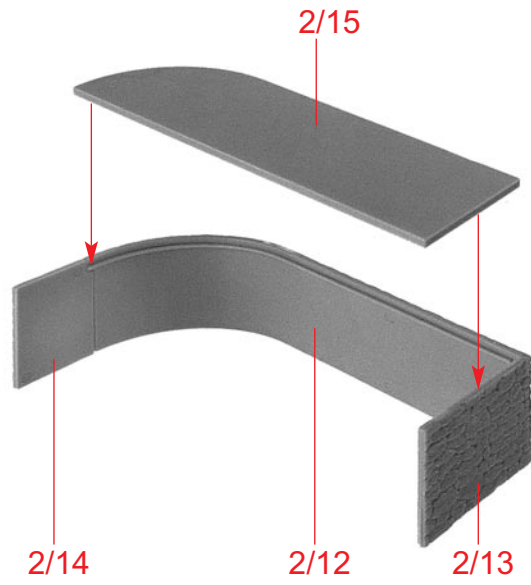

(a)

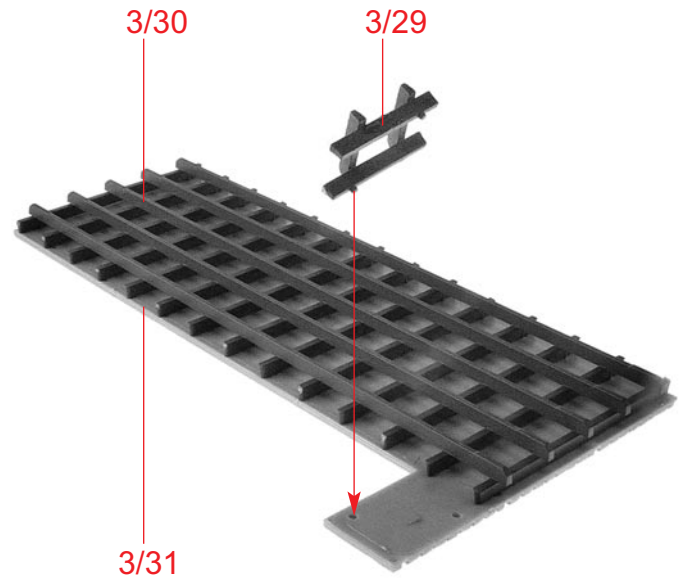

(b)

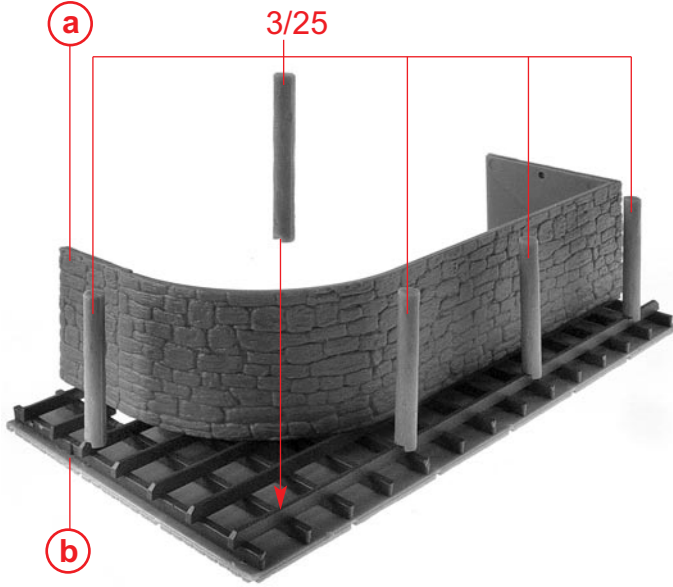

(c)

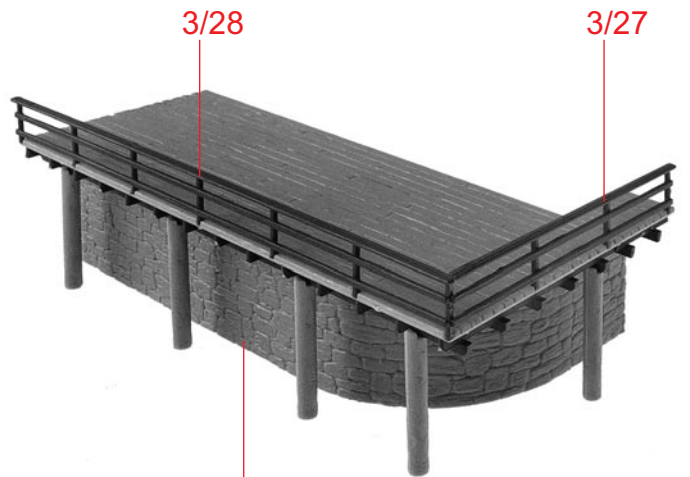

(d)

3/26

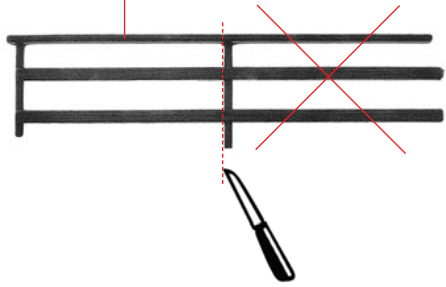

e

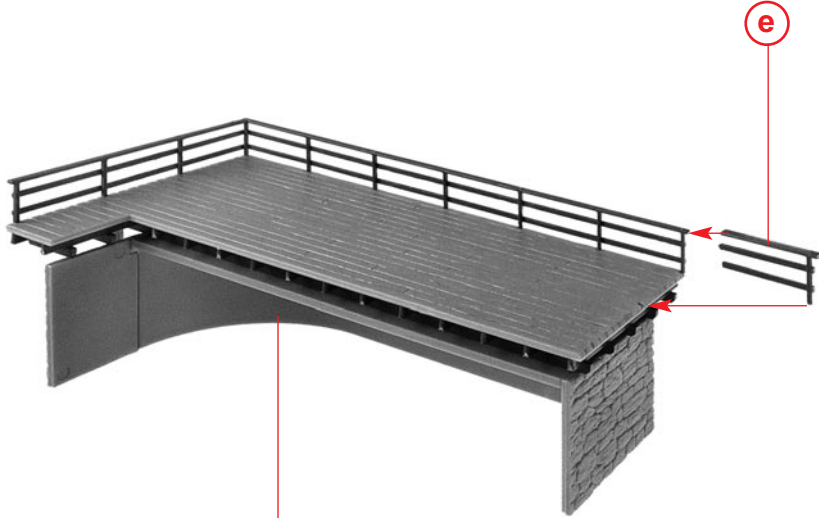

f

d

Z

9

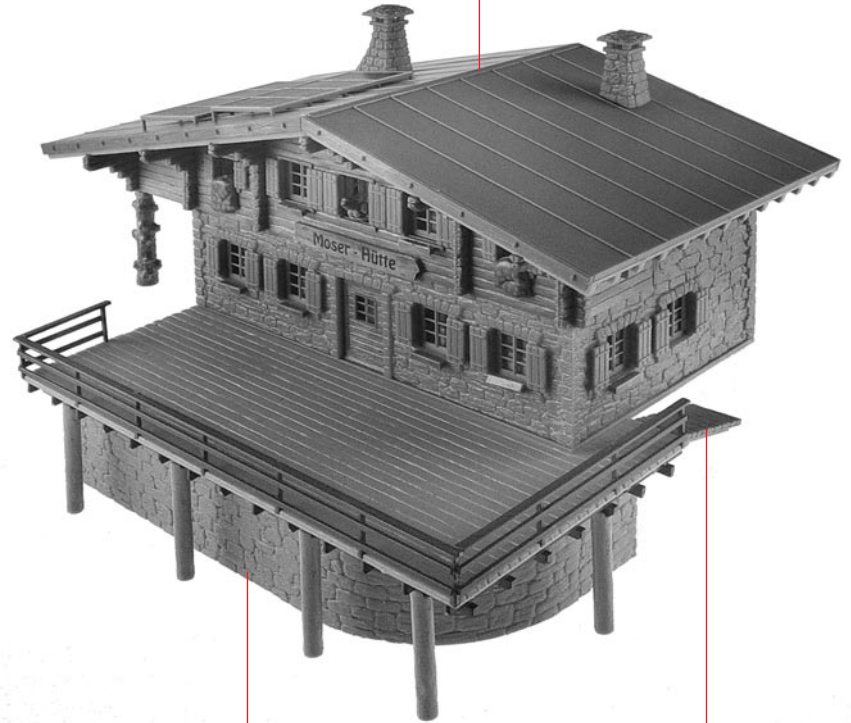

g

f

3/18

10

h 16 x

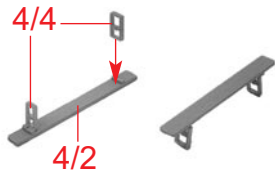

i 4 x

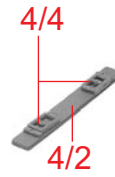

j 4 x

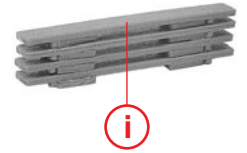

k 8 x

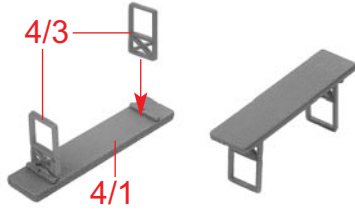

l 2 x

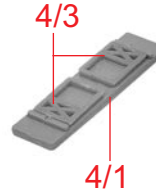

m 2 x

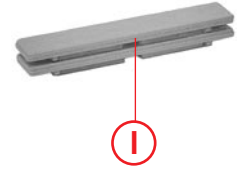

Deco 1

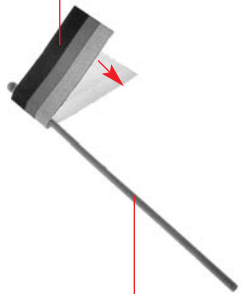

5/13

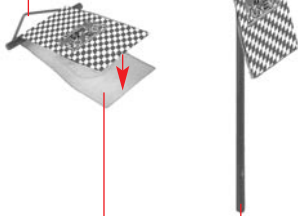

n 5/14

n Deco 1 5/12

g

n

k

h

9/9

o

j

m

n

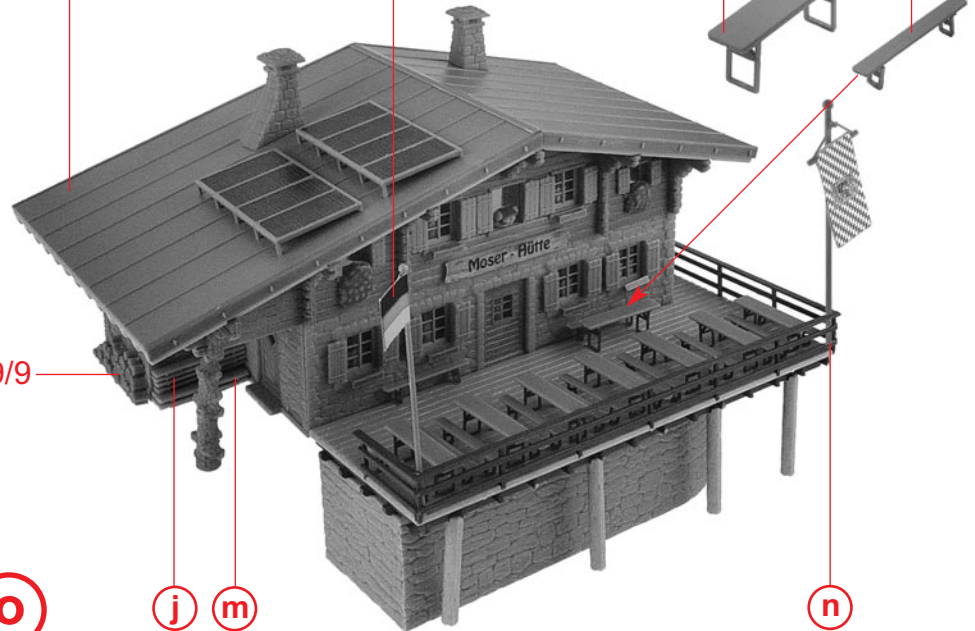

p 2 x

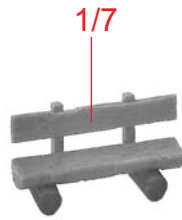
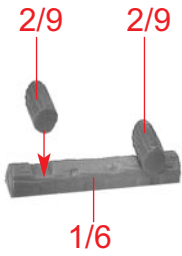

q

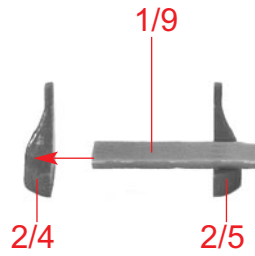

r

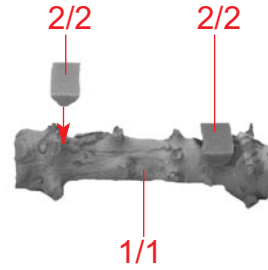
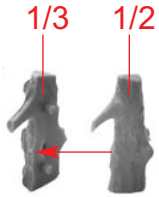

s 3 x

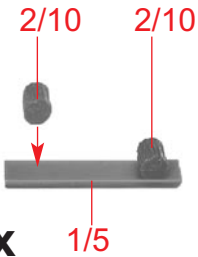

t

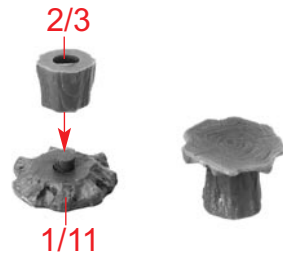

u

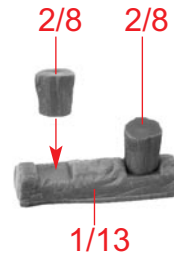

v 2 x

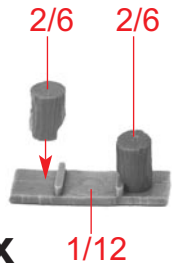

w 4 x

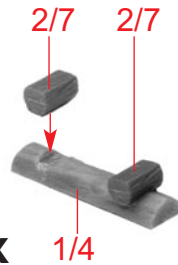

x

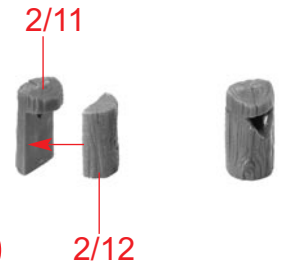

12

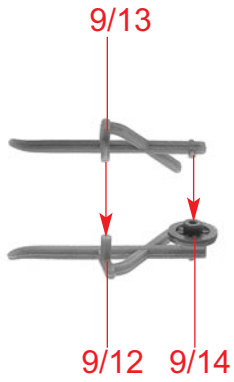

y

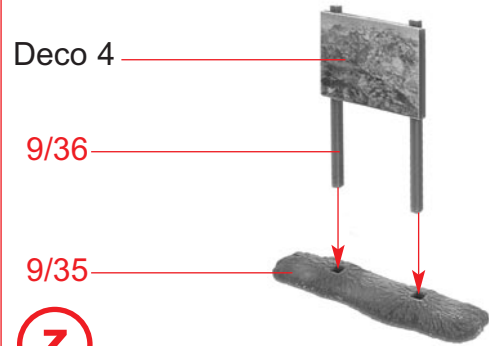
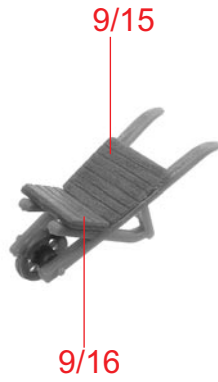

z

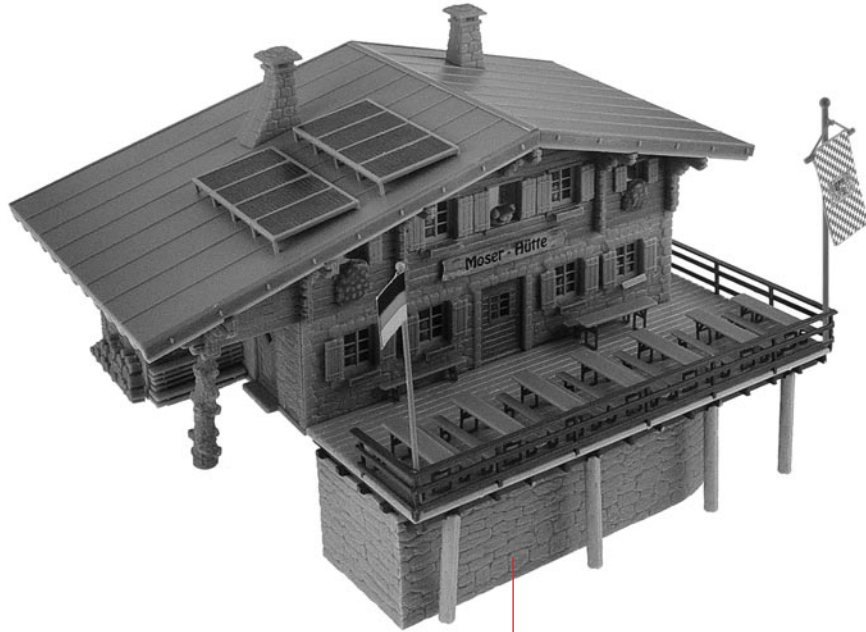

A

o

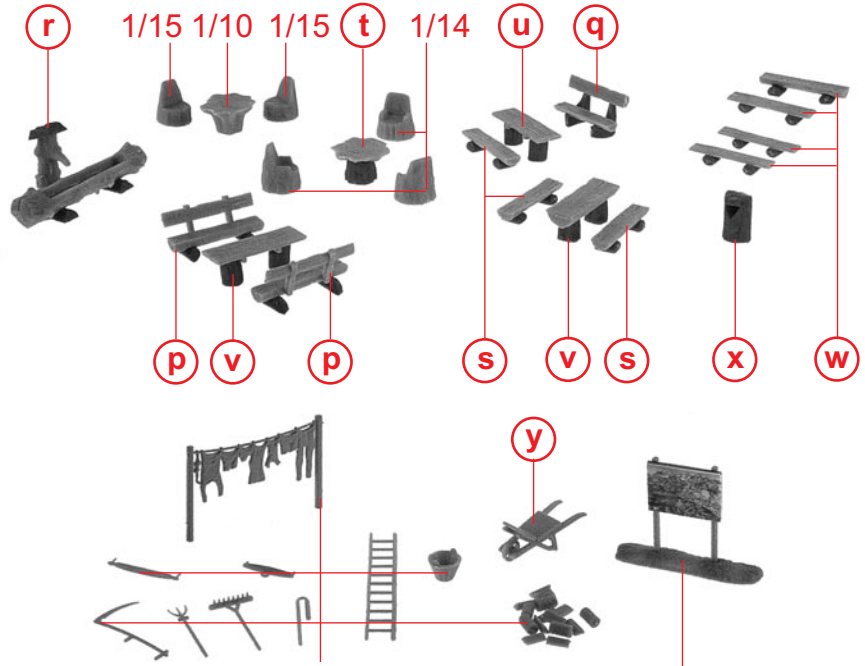

Ausschmückungsteile
 Decoration parts
 D'éléments décoratifs
 Decoratiedelen

z